

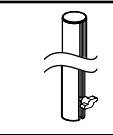









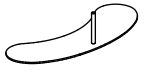

Item #	Illustration	Part Number	Qty.	Item #	Illustration	Part Number	Qty.
1		PA-01P 15-00050-017 17" High Post With Knob	1	7	 <i>Includes hardware</i>	LA-17P 15-00048-17P Flat Panel Monitor Mount	2
2		LA-17QQ 15-00220-010 Post Clamp	1	8		100-MM-PLATE 15-00090-100 100 mm Mounting Plate	2
3		82-04100-100 Desktop LCD Holder (Base)	1	9		83-28002-097 Weld Nut 1/4-20 Thread	4
4		15-00090-078 Adapter For Duo Command Deskmount	1	10		83-28001-140 1/4-20 x 3/8" Socket Head Cap Screw Black	4
5		15-00092-078 Mounting Plate For Command Deskmount	1	11		83-28001-009 M6 x 8mm Metric Slot Head Screw	2
6	 <i>Includes hardware</i>	PA-01T-24 15-HE501-024 Flat Panel Display Track 24"	1	12		83-28004-015 #8 Split Lock Washer Zinc Plated	4
				13		83-28002-058 8-32 Hex Nut	4

Assembly View

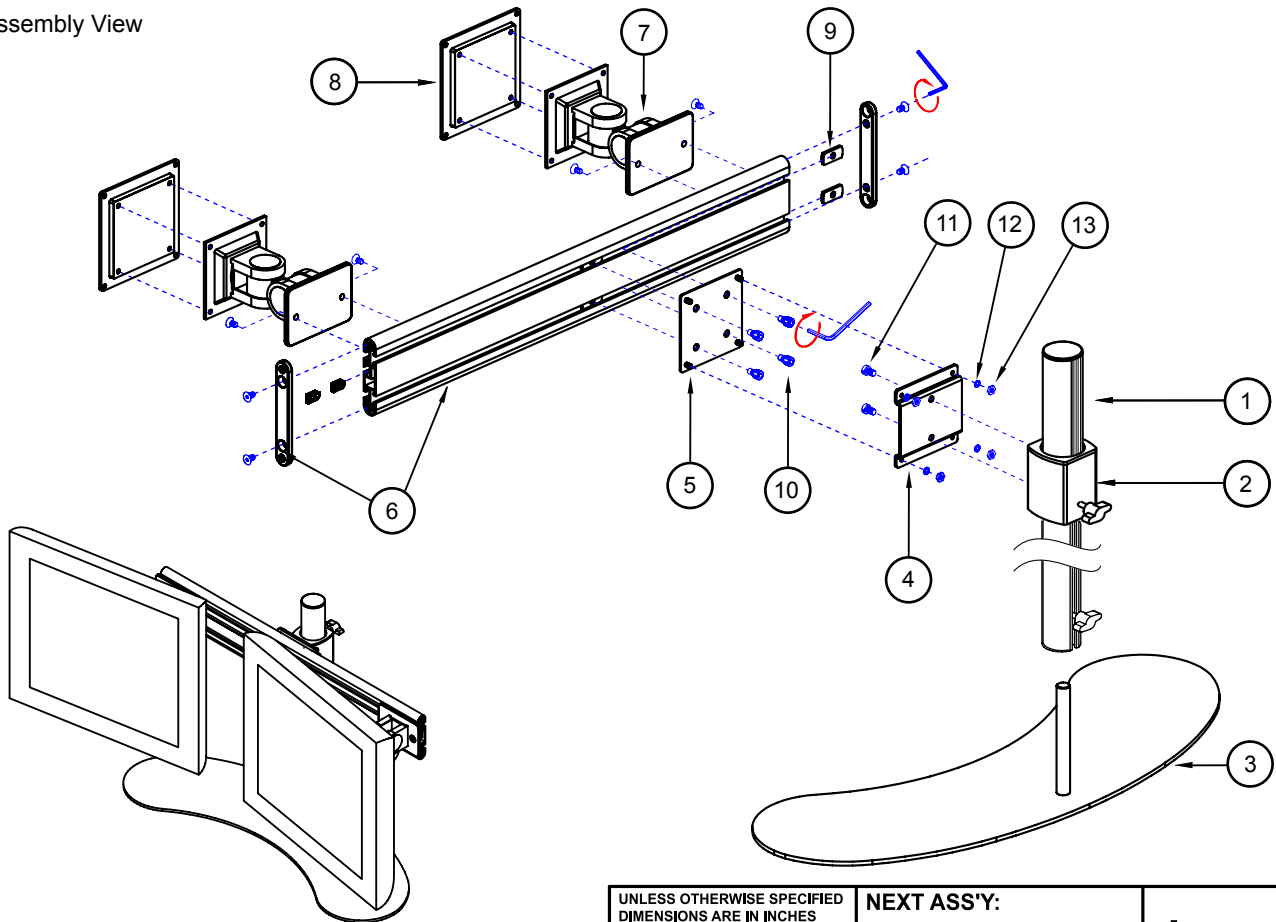

UNLESS OTHERWISE SPECIFIED
 DIMENSIONS ARE IN INCHES
 TOLERANCES
 2 PL DECIMALS ± .01
 3 PL DECIMALS ± .005

NEXT ASS'Y:

DATE: