







Item #	Illustration	Part Number & Description	Qty.
1		83-02000-105 Storage Bin 2"H	1
2		83-02000-109 Mounting Bracket for Storage Bins	1
3		83-28002-015 10-32 Acorn Nut	4
4		83-28001-033 1/4-20 x 3/4 Philips HD	2
5		83-28004-005 1/4" Washer	2
6		83-28002-045 1/4-20 Hex Nut	2



Assembly View

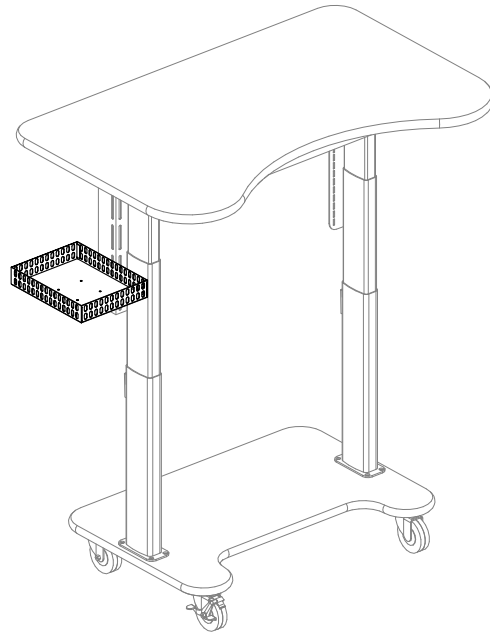
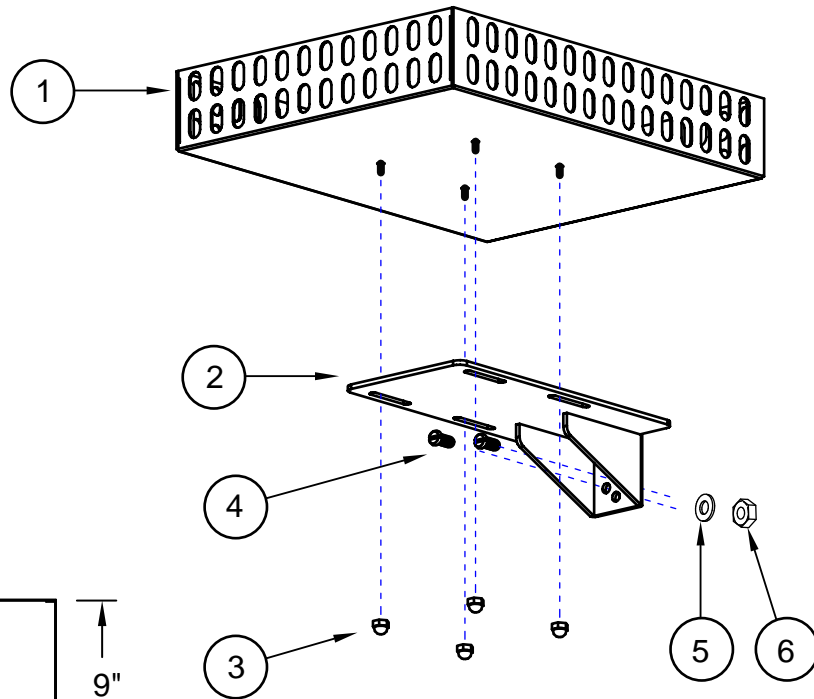

Mounts in either direction

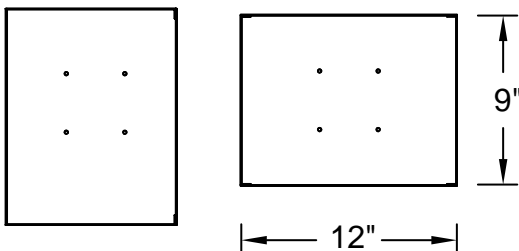

UNLESS OTHERWISE SPECIFIED
 DIMENSIONS ARE IN INCHES
 TOLERANCES
 2 PL DECIMALS ± .01
 3 PL DECIMALS ± .005

NEXT ASS'Y:

DATE: 03/02/09